

Restaurant Equipment Quiz

Instructions

Fees: \$25

1. Print these pages.
2. Answer the **Simple questions** that follow mini sections of the code language.
3. Circle the correct answers and transfer the answers to the [answer sheets](#) (see last 3 pages).
4. After answering the simple questions you will become familiar with the new code changes.
5. Page down to the last page for the [verification form](#), answer sheets and mailing instructions.

3 hour course for:

- | | |
|----------------------------------|--|
| 1. Master Plumber | 4. UDC Plumbing Inspector |
| 2. Journeyman Plumber | 5. Master Plumber Restricted Appliance |
| 3. Commercial Plumbing Inspector | 6. Journeyman Plumber Restricted Appliance |

Questions call Gary or Amy Klinka at 920-727-9200 or 920-740-6723 or email garyklinka@hotmail.com

Glasswashers and Dishwashers

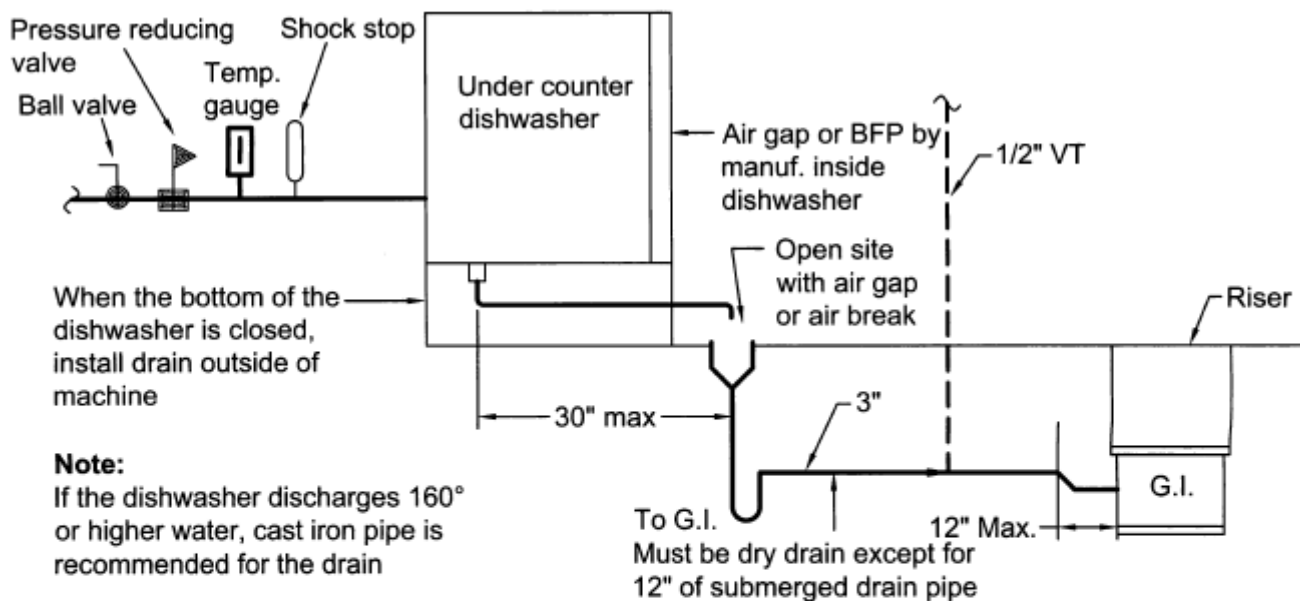

Drain Options

UNDER COUNTER COMMERCIAL DISHWASHERS

Some under counter dishwashers discharge as a dump machine meaning that they do not have a pump. However, there are under counter dishwashers which have a pump, when the machine has a pump, then the drain may be in the floor or in the wall.

When the drain is in the floor, it may be installed under the machine (if accessible) or to one side or the other as shown above. Access to the drain is required and when the drain is in the wall or above floor, a pump type dishwasher is required. The top of the drain which receives the discharge from the dishwasher shall be as required by the manufacturer. Some machines will only pump 12" high but others can pump up to 42" high. Therefore, the installer must have the rough-in drawings before installation.

1. When the above dishwasher drain is in the floor, it may be installed under the machine only if it is _____.
- a. available
 - b. accessible
 - c. both a & b
 - d. none of the above

2. Access to the above dishwasher drain is required and when the drain is in the wall or above floor, a _____ dishwasher is required.
- gravity
 - pressure
 - pump
 - all of the above
3. Some dishwashing machines will only pump 12" high but others can pump up to ____" high.
- 18
 - 24
 - 36
 - 42

Water Options

Hot water for dishwashers can be 180° or 140°. If 140° water is provided, then a sanitation device is provided for the dishwasher. In most machines, if 180° is required, then a pre-heater is part of the machine. A pressure reducing valve reducing the water pressure to 25 psi is required. Also a shock stop and temperature gauge should be part of the installation.

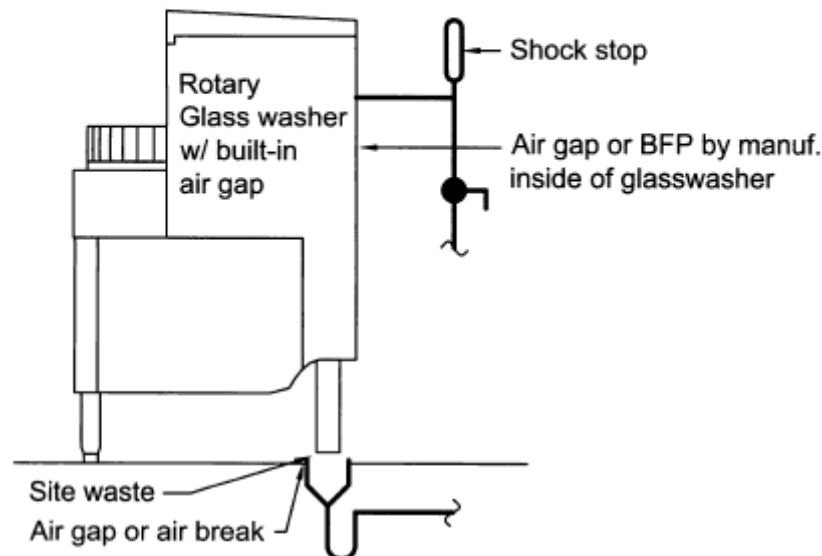

4. A pressure reducing valve reducing the water pressure to 25 psi is _____ for the above figure.
- recommended
 - optional
 - required
 - all of the above
5. A _____ should be part of the installation.
- shock stop
 - temperature gauge
 - neither a or b
 - both a or b

Under Counter Commercial Dishwashers

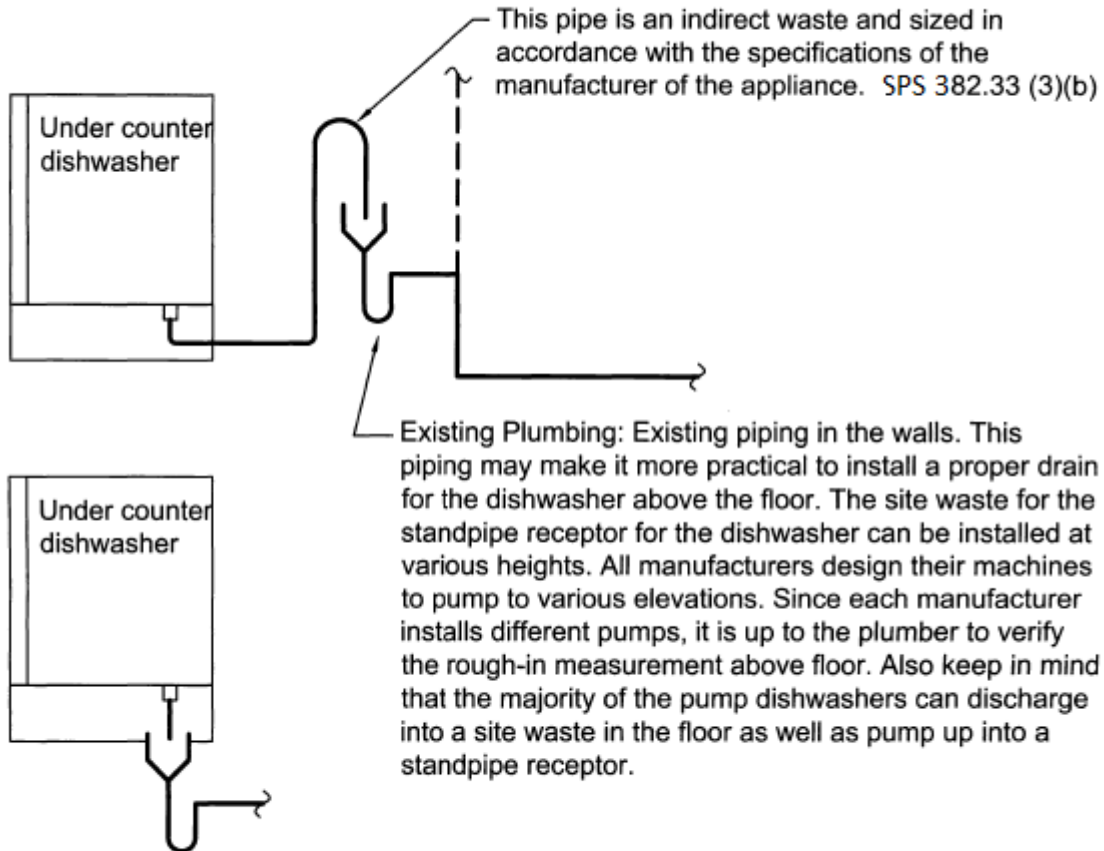

If the machine has a pump, it could be piped as shown without draining the contents of the washing or rinsing cycles of the dishwasher because the drain has a positive closure.

6. Existing Plumbing: All manufacturers design their machines to pump to various elevations. Since each manufacturer installs different pumps, it is up to the _____ to verify the rough-in measurement above floor.

- a. Inspector
- b. owner
- c. plumber
- d. any of the above

7. Existing Plumbing: The majority of the pump dishwashers can discharge into a _____.

- a. site waste in the floor
 - b. standpipe receptor (pump up)
 - c. both a & b
 - d. none of the above
-

Commercial dishwashers must discharge into a vented and trapped receptor or site waste by means of an air gap or an air break. The indirect waste pipe (the piece of pipe from the machine to the vented and trapped receptor) may not be more than 30" in length. See SBS 3 82.33 (9)(d) 2.

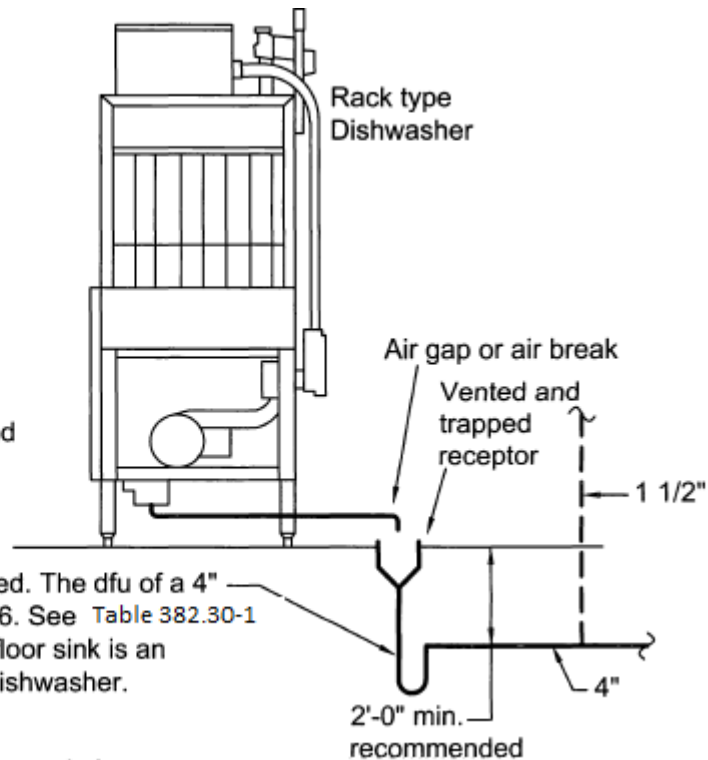

8. The indirect waste pipe (the piece of pipe from the machine to the vented and trapped receptor) may not be more than ___ in length.

- 30"
- 30'
- 36"
- 48"

9. Commercial dishwashers must discharge into a vented and trapped receptor or site waste by means of an _____.

- air gap
- air break
- both a or b
- none of the above

10. A floor sink is not acceptable method of draining a dishwasher.

- true
 - false
-

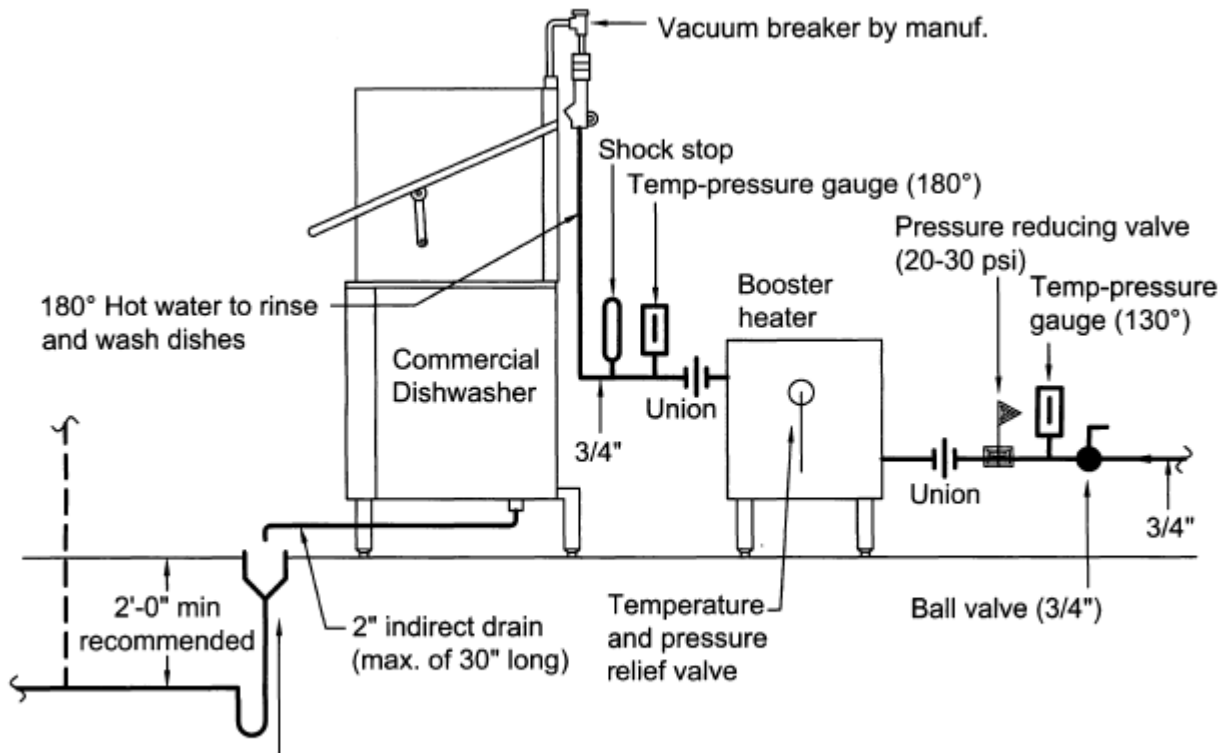

Vented and trapped receptor. SPS 382.33 (9)(d) 2. Indirect waste pipe (30" max.) SPS 382.33 (9)(d) 2. 4" Minimum drain - Table 382.31-1 (Dishwasher, Commercial) Fixture unit value of 4" receptor is 6. Table 382.31-1 Minimum size vent - Table 382.31-1 Minimum drain size of dishwasher receptor - Table 382.31-1.

11. The code section for the minimum drain size of dishwasher receptor would be table _____.
 - a. 82.30-1
 - b. 82.33(9)(d)2
 - c. 82.31-3
 - d. 82.33-2
 12. The code section for Vented and trapped receptor would be table _____.
 - a. 82.30-1
 - b. 82.33(9)(d)2
 - c. 82.31-3
 - d. 82.33-2
 13. The code section for the minimum size vent would be table _____.
 - a. 82.30-1
 - b. 82.33(9)(d)2
 - c. 82.31-3
 - d. 82.33-2
-

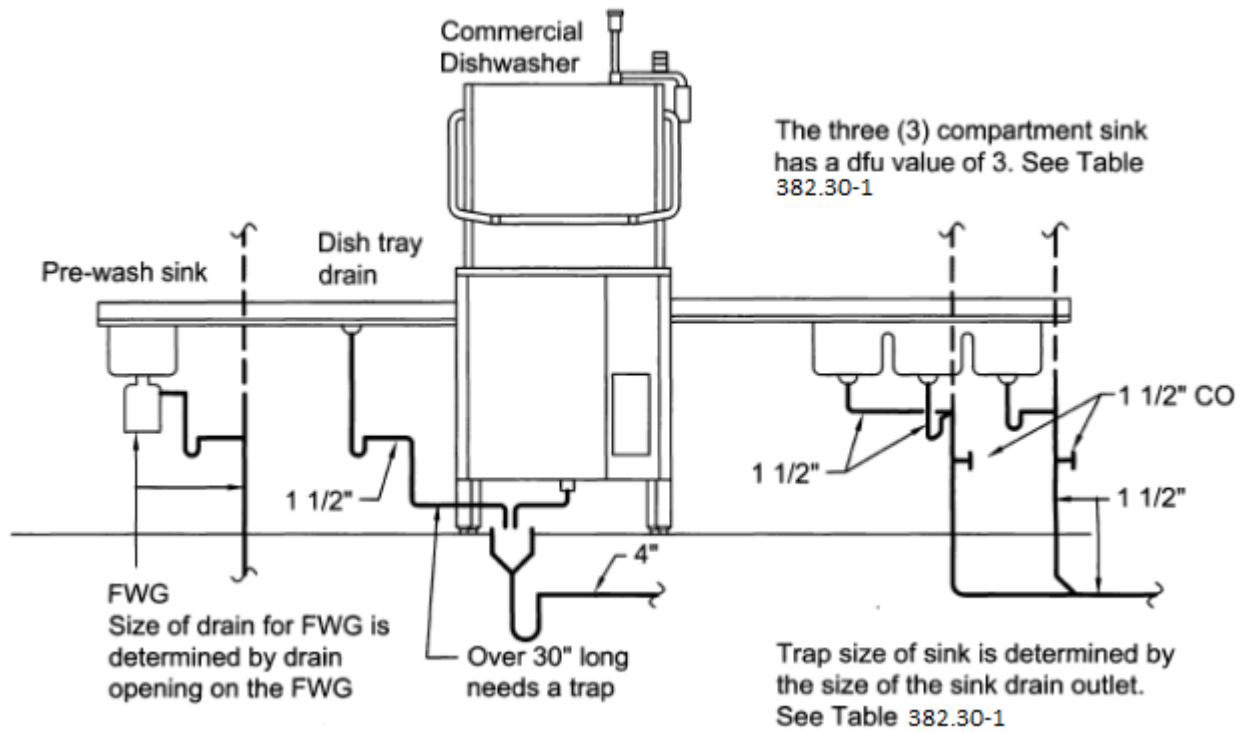

14. Trap size of sink is not determined by the size of the sink drain outlet.
- a. true
 - b. false

Coffee Brewers, Cappuccino Machines, Soda Fountains

Coffee Brewer (wsfu = .5) Table 382.40-2

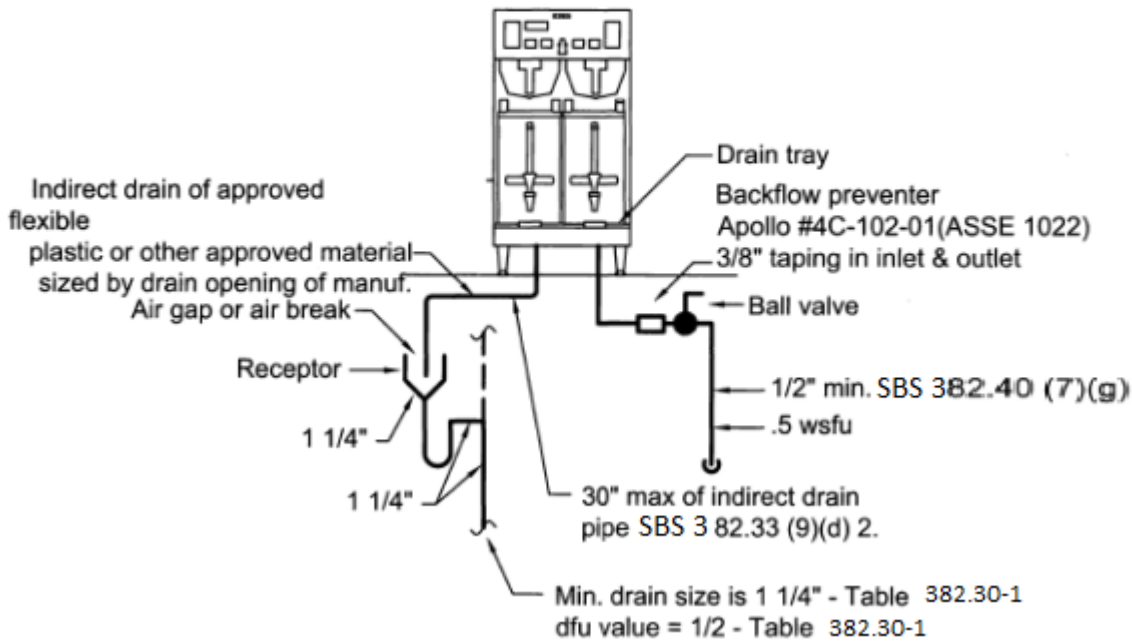

15. The above beverage machine does not need backflow protection by code.
- a. true
 - b. false

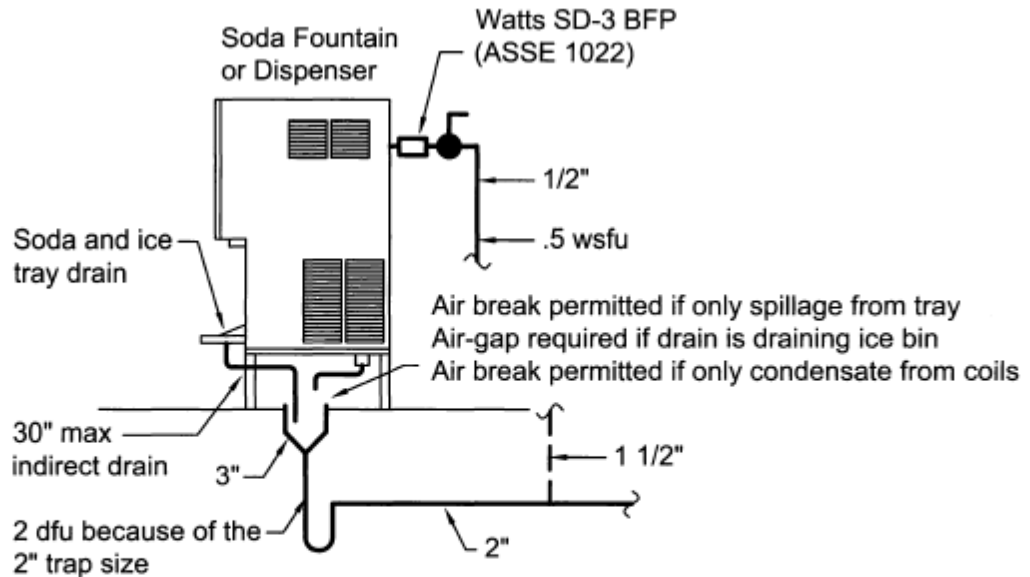

The drain from the soda & ice tray is draining spillage and is permitted to discharge by means of an air break. The second drain discharging from the bottom of the Dispenser must discharge by means of an air gap if it is draining an ice bin or similar. If it is draining a condensate area of the Dispenser, it would be permitted to drain by means of an air break.

16. If it is draining a condensate area of the Dispenser, it would be permitted to drain by means of an _____.

- a. air break
- b. air gap
- c. both a or b
- d. backflow preventer

17. The second drain discharging from the bottom of the Dispenser must discharge by means of an _____ if it is draining an ice bin or similar.

- a. air break
- b. air gap
- c. both a or b
- d. backflow preventer

18. The drain from the soda & ice tray is draining spillage and is permitted to discharge by means of an _____.

- a. air break
- b. air gap
- c. both a or b
- d. backflow preventer

Coffee Brewers, Coffee Urns

Coffee Brewer

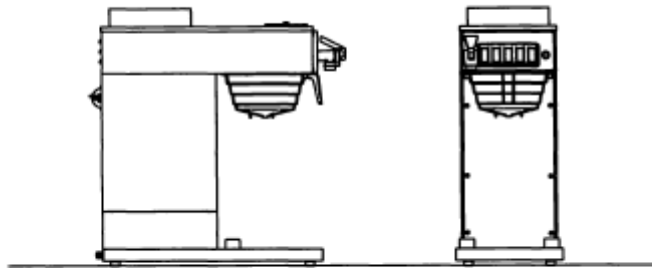

Coffee Brewer (automatic coffee brewer) Some units are provided with a hot water faucet. Requires an ASSE 1022 backflow preventer. IE: Apollo No. 4C-102-01
Plumbing: 20-80 psi. Machine supplied with 1/4" male flare fitting

Coffee Urn

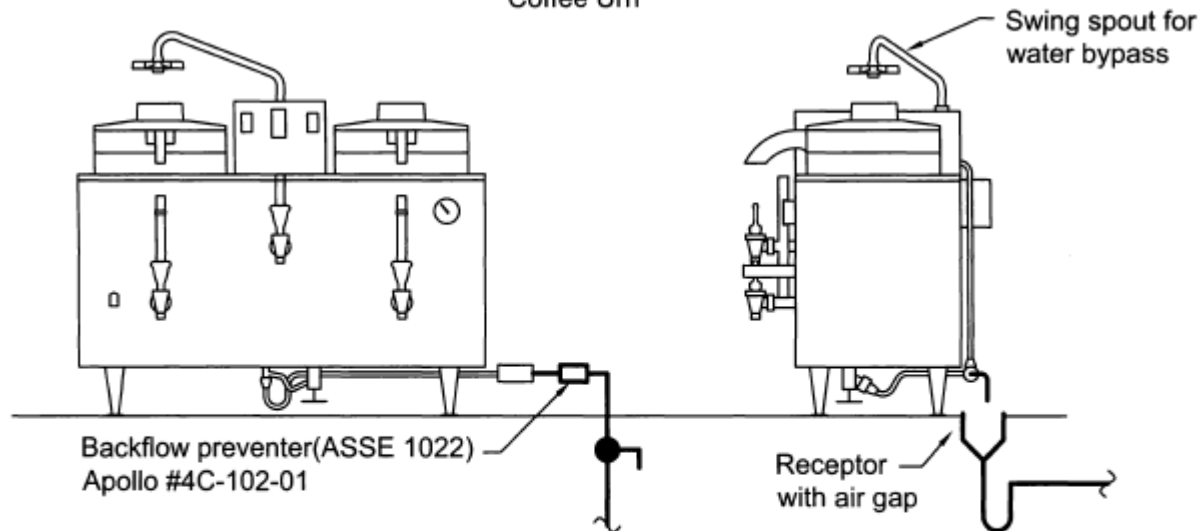

Coffee urn with 3/8" male fitting. The model shown is with a swing spout for water by-pass, water connection at side and back of unit. Requires an ASSE 1022 back flow preventer. IE: Apollo No. 4C-102-01. Provide an air-gap on the drain. Install a filtering device if required.

19. Coffee Urn: Must be provided with an _____ the drain.
- air break
 - air gap
 - both a or b
 - backflow preventer
20. Automatic coffee brewer must be provided with a _____ the drain.
- air break
 - air gap
 - both a or b
 - backflow preventer
21. A filter device for a _____ is required.

- a. automatic coffee brewer
- b. coffee um
- c. both a & b
- d. none of the above

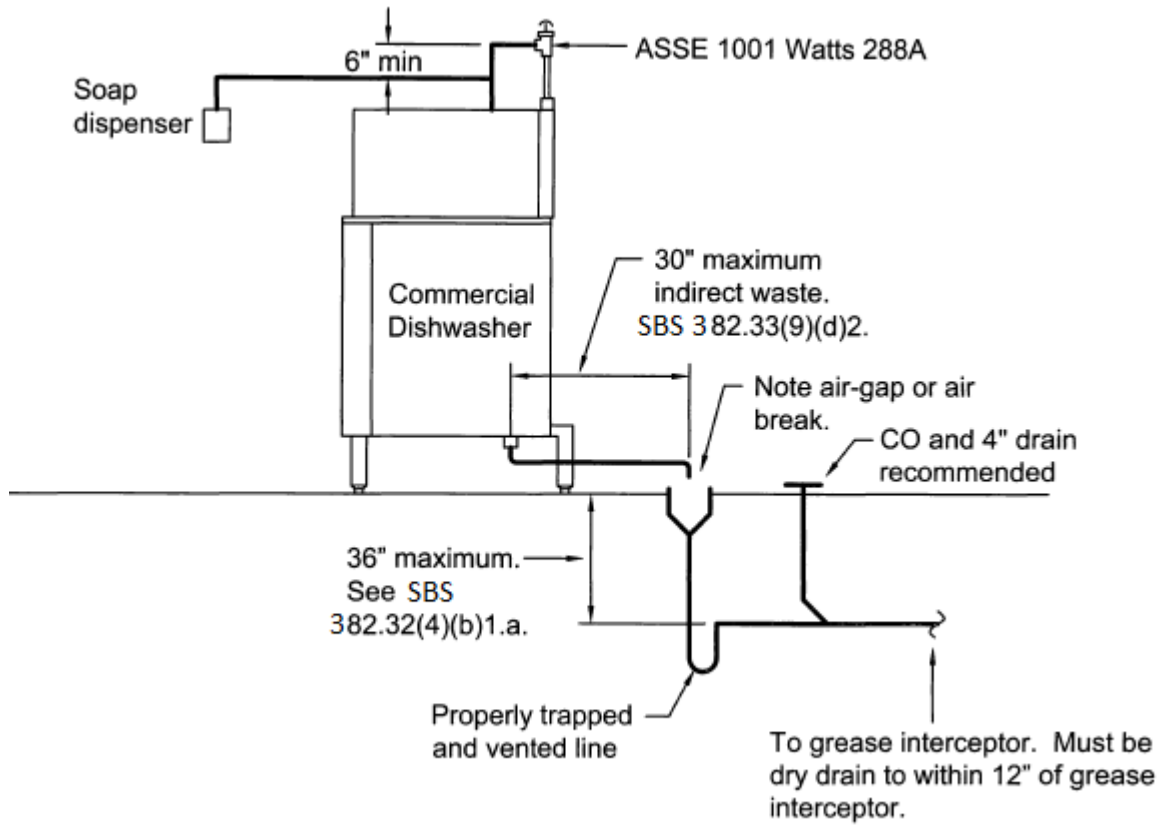

22. The drain from a commercial dishwasher is permitted to discharge by means of an _____.
- a. air break
 - b. air gap
 - c. both a or b
 - d. backflow preventer

SBS 382.33(9)2.a.

The temperature of the water discharging from a steamer is usually over 160° and therefore shall have iron piping or piping which can withstand the high temperatures

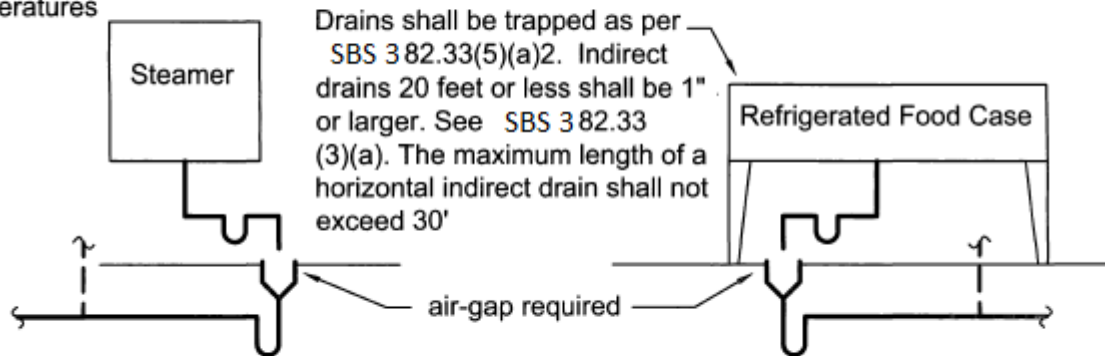

Materials for the receptor drain and related piping for a steamer shall be capable of withstanding high water temperatures.

23. Materials for the receptor drain and related piping for a steamer **should** be capable of withstanding high water temperatures.

- a. true
- b. false

24. Indirect drains for a refrigerated food cases shall be ____" for drains 20' or less.

- a. 1/2
- b. 3/4
- c. 1
- d. 1 1/4

25. The temperature of the water discharging from a steamer is usually over 160° and therefore shall have _____.

- a. piping which can withstand the high temperatures
 - b. iron piping
 - c. any metal piping method
 - d. both a & b
-

Chinese ranges that are provided with multiple frying kettles and multiple faucets with 1/2" water piping installed at the factory to serve those faucets would be acceptable to the Department of Commerce if all other codes are met.

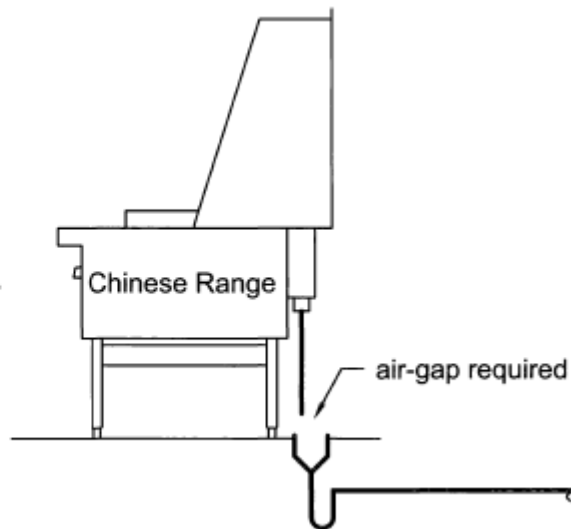

26. Chinese ranges that are provided with multiple frying kettles and multiple faucets with 1/2" water piping _____ to serve those faucets would be acceptable to the Department of Commerce if all other codes are met.

- a. field install
- b. installed at the factory
- c. none of the above
- d. both a & b

For salad cases with bottom automatic water fills approved backflow preventer would be ASSE 1056 (Watts #008) or ASSE 1013 (Watts #919, #909)

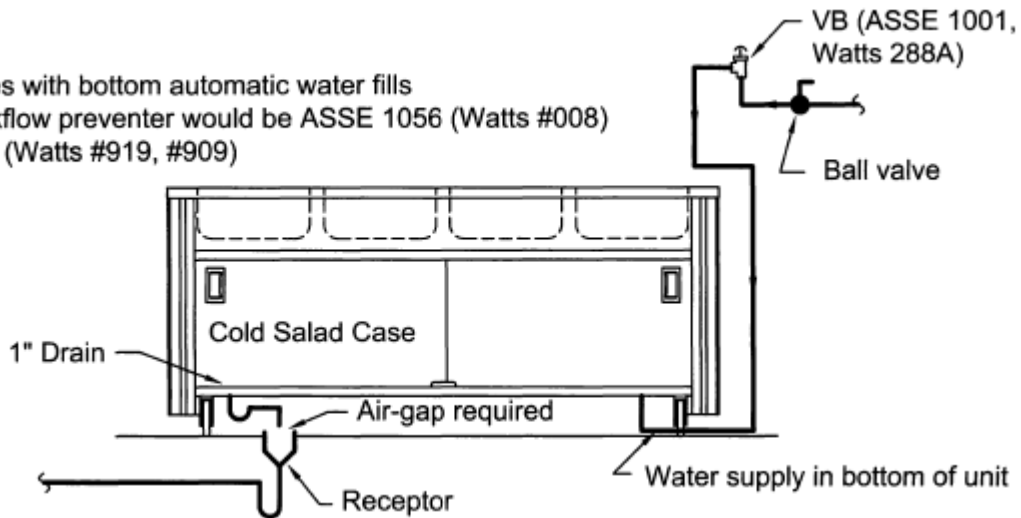

27. Salad cases with top automatic water fills approved backflow preventer would be ASSE 1056 or ASSE 1013.

- a. true
- b. false

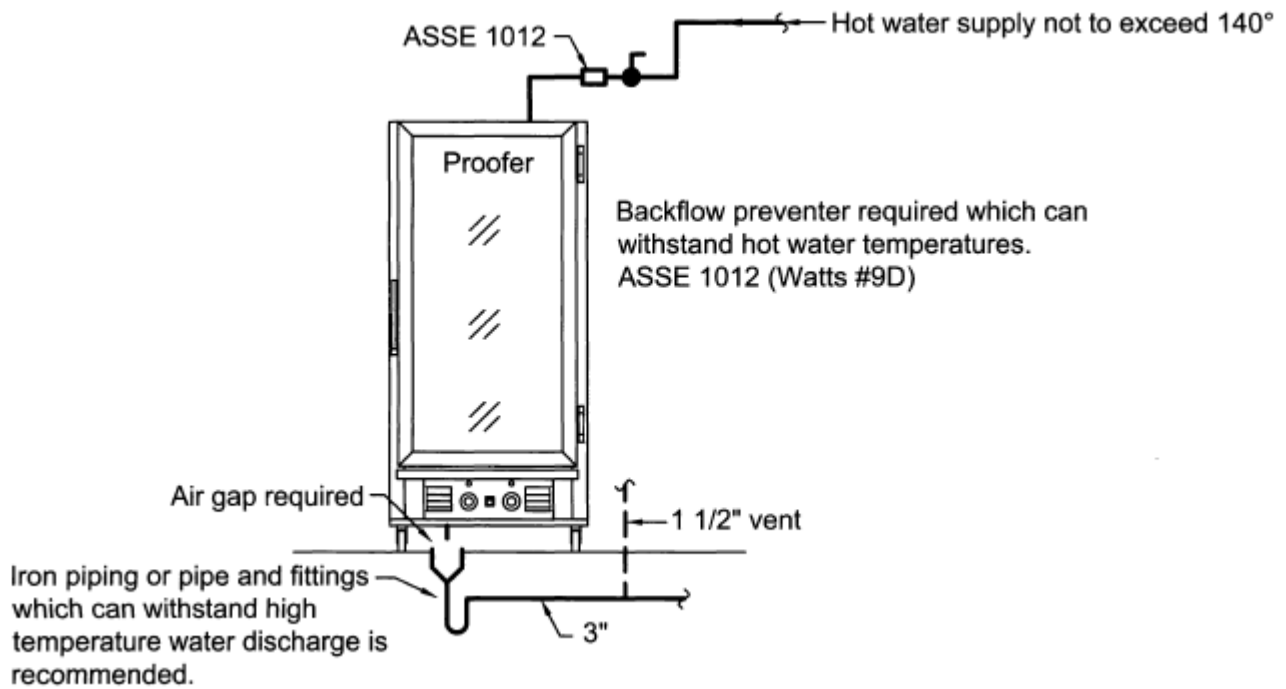

28. The hot water supply to a proofer should not exceed ____ degrees.
- a. 120
 - b. 140
 - c. 160
 - d. none of the above

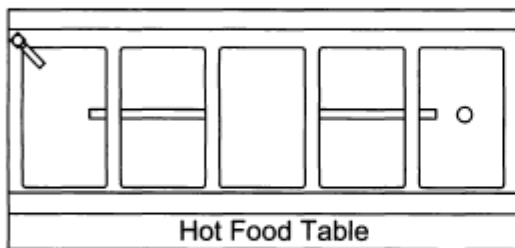

Water fill is above rim of hot food table and will not require back flow protection

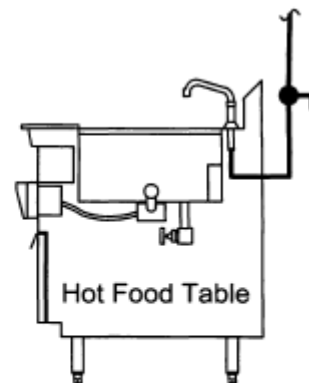

Provide trap on drain, 1" minimum. Extend 1" indirect waste to receptor drain. Drain air gap required.

DRIP PANS FOR Coffee Makers, Beer Taps,
Glass Fillers & Soda Dispensers

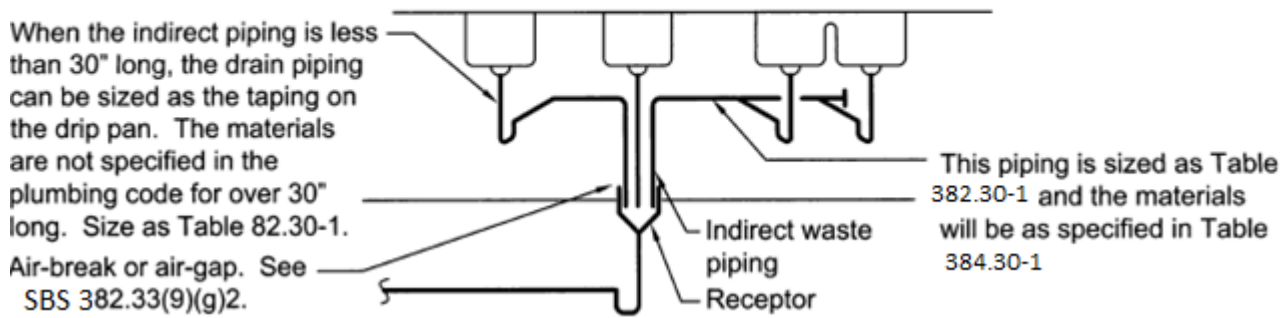

29. The drains for above diagram can discharge by the means of _____.

- a. air break
- b. air gap
- c. both a or b
- d. backflow preventer

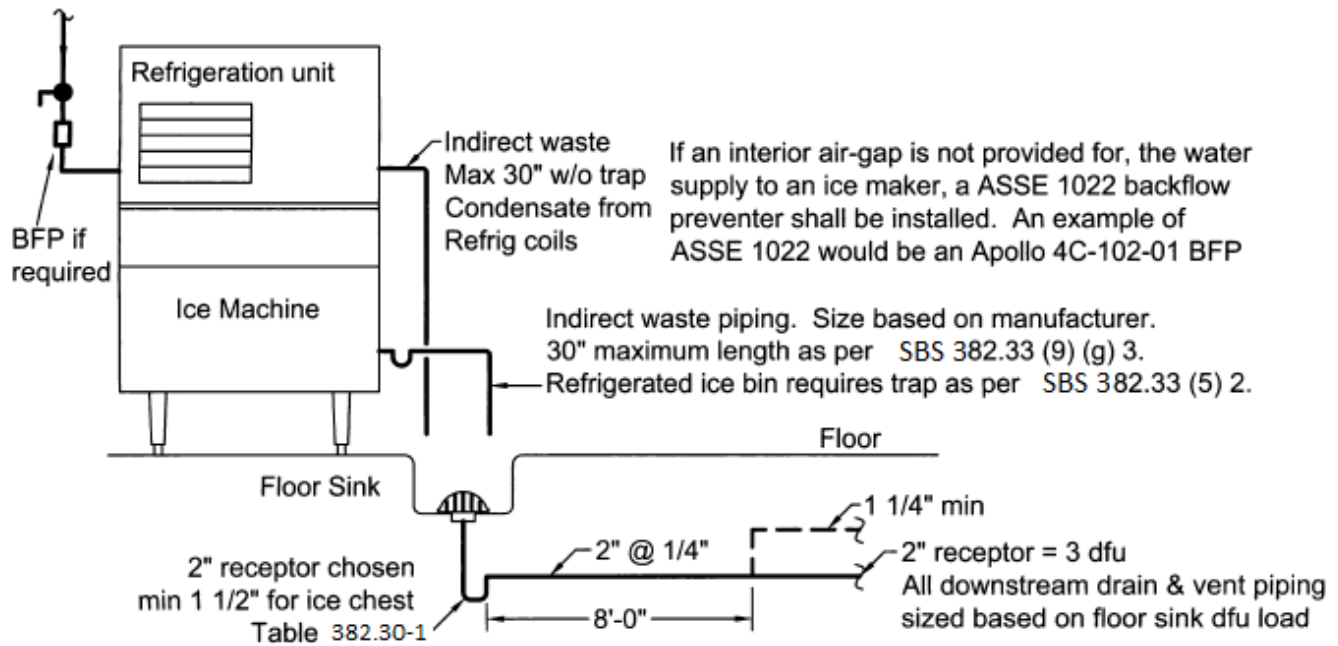

30. If an interior air-gap is not provided for the above diagram, the water supply to an ice maker, a ASSE _____ backflow preventer shall be installed.

- a. 1021
- b. 1022
- c. 1012
- d. none of the above

ENCLOSED FOOD PROCESSING EQUIPMENT

Such as coffee urns, egg boilers, potato peelers & steam kettles shall be provided with an air-gap. See SBS 382.33(9)(g)5.

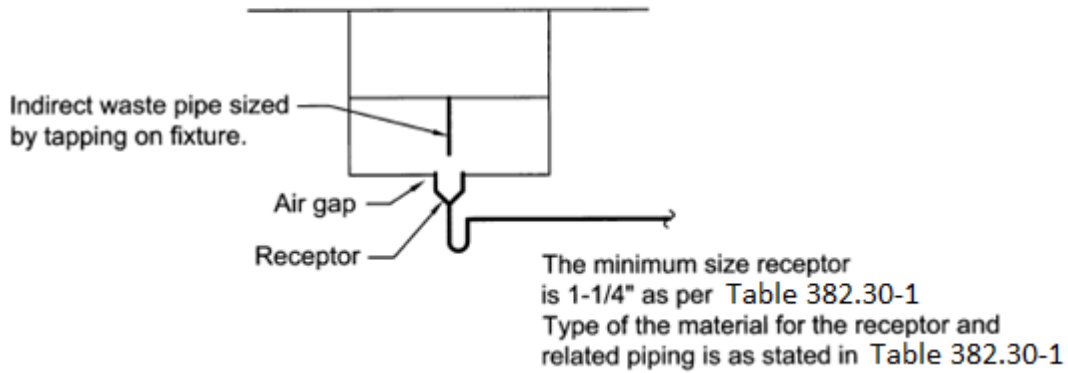

Waitress Station With Water Tower And Ice Compartment

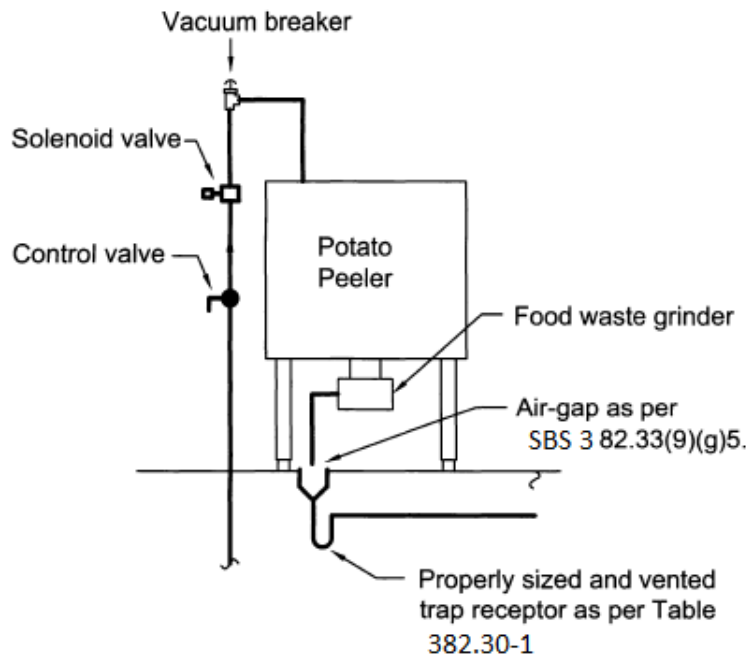
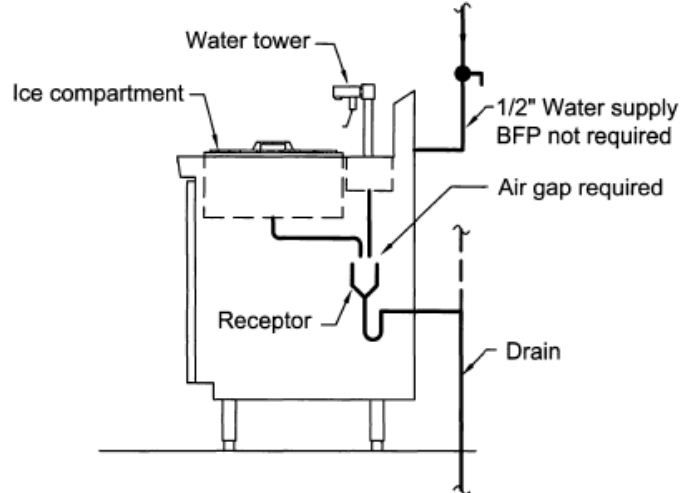

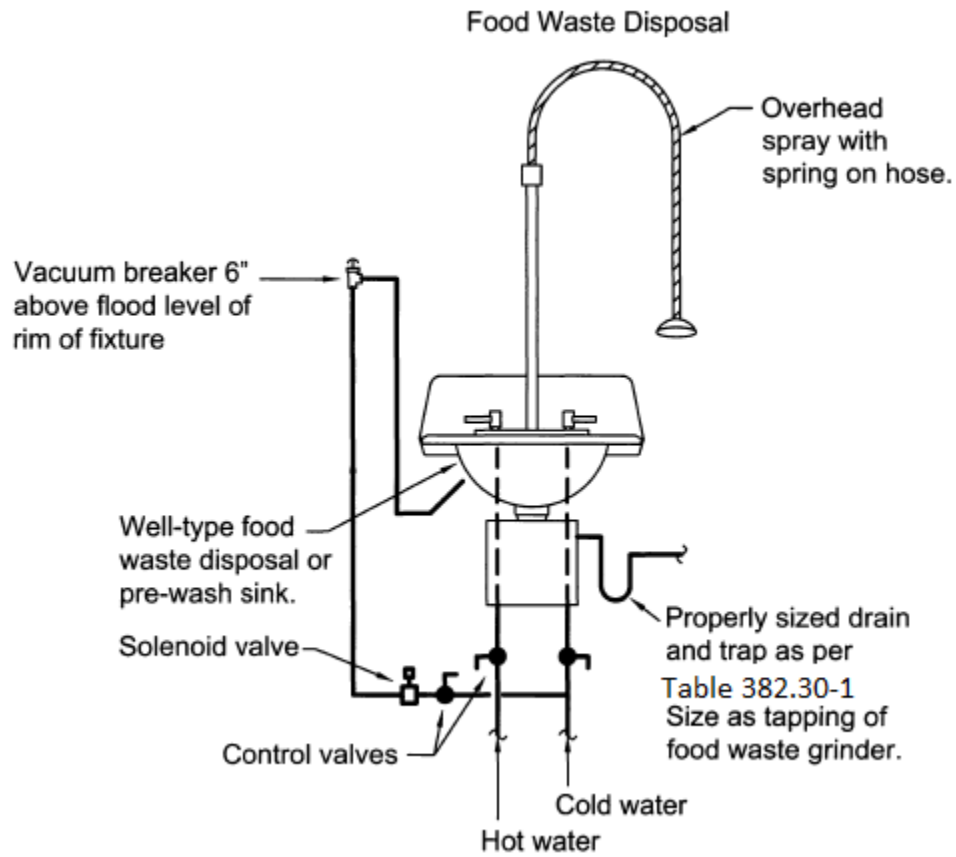

Restaurant Equipment Quiz-Answer Sheet

- 1 a b c d
- 2 a b c d
- 3 a b c d
- 4 a b c d
- 5 a b c d
- 6 a b c d
- 7 a b c d
- 8 a b c d
- 9 a b c d
- 10 a b c d

- 11 a b c d
- 12 a b c d
- 13 a b c d
- 14 a b c d
- 15 a b c d
- 16 a b c d
- 17 a b c d
- 18 a b c d
- 19 a b c d
- 20 a b c d

- 21 a b c d
- 22 a b c d
- 23 a b c d
- 24 a b c d
- 25 a b c d
- 26 a b c d
- 27 a b c d
- 28 a b c d
- 29 a b c d
- 30 a b c d

To obtain your Continuing Education Credits follow the below instructions.

1. Print out first.
2. Fill in all fields applicable.
3. Include your certification or license number if applicable.
4. We'll take care of crediting with the state and sending you back a verification form.

Send by mail

Fees: \$25

- 1. The answer sheet and this page only.**
2. Fill out this form below completely.
3. Applicable fees by check payable to Gary Klinka.
4. Mail to: Gary Klinka at 228 Mandella Ct Neenah WI 54956.

Office 920-727-9200 Fax 888-727-5704 Cell 920-740-6723 or 920-740-4119

Email: garyklinka@hotmail.com

-----Educational Course Attendance Verification Form -----

Attendee's Name _____ Date _____

Address _____

Credential Number _____ Phone# _____

Course Title and Name _____ Restaurant Equipment Quiz _____

List each credential held by attendee _____

_____ Credited Hours 3 hrs. Fee: \$25

Email address _____ Fax# _____

To be completed by Gary Klinka www.garyklinka.com My credential link [#70172](#)

Course Password _____ Course ID# _____

Attendee passed the course with a greater than 70% score on Date _____

Instructor Signature _____